

P2036 300 MHz / P2056 500 MHz  
10:1 oscilloscope probes

User's Guide



## EC declaration of conformity

Pico Technology declares that the following products comply with the requirements of the specified Directives and Standards as listed below. Technical documentation required to demonstrate compliance to the standards is available for inspection by the relevant enforcement authorities. Products carry the CE mark.

### Products covered by this declaration:

P2036	300 MHz 10:1 oscilloscope probe
P2056	500 MHz 10:1 oscilloscope probe

### EU Directives covered by this declaration:

2014/35/EU	<i>Low Voltage Equipment Directive</i>
2012/19/EU	<i>Waste Electrical and Electronic Equipment</i>
2011/65/EU	<i>Restriction of use of certain Hazardous Substances</i>

### The basis on which conformity is being declared:

EN61010-1:2010	<i>Safety requirements for electrical equipment for measurement, control and laboratory use, general equipment requirements.</i>
EN61010-031:2015	<i>Safety requirements for hand-held probe assemblies for electrical measurement and test.</i>
RoHS and WEEE	<i>Manufacturer's analysis of the raw materials used in the manufacture of the above products.</i>

Your help and efforts are required to protect and keep our environment clean. Therefore either return this product at the end of life to the manufacturer or ensure WEEE compliant collection and treatment yourself. Do not dispose of as unsorted municipal waste.



## Warranty

Pico Technology warrants this oscilloscope accessory for normal use and operation within specifications for a period of two years from date of shipment and will repair or replace any defective product which was not damaged by negligence, misuse, improper installation, accident or unauthorized repair or modification by the buyer. This warranty is applicable only to defects due to material or workmanship. Pico Technology disclaims any other implied warranties of merchantability or fitness for a particular purpose. Pico Technology will not be liable for any indirect, special, incidental, or consequential damages (including damages for loss of profits, loss of business, loss of use or data, interruption of business and the like), even if Pico Technology has been advised of the possibility of such damages arising from any defect or error in this manual or product.

Made in Germany.

Information in this publication supersedes that in all previously published material.

*Pico Technology* is a registered trade mark of Pico Technology Ltd.

Copyright © 2020 Pico Technology Ltd. All rights reserved.

## Safety

To prevent possible electrical shock, fire, personal injury, or damage to the product, carefully read this safety information before attempting to install or use the product. In addition, follow all generally accepted safety practices and procedures for working with and near electricity.

The product has been designed and tested in accordance with the European standard publication EN 61010-031:2015, and left the factory in a safe condition.





The following safety descriptions are found throughout this guide:

A **WARNING** identifies conditions or practices that could result in injury or death.

A **CAUTION** identifies conditions or practices that could result in damage to the product or equipment to which it is connected.

## Symbols

These safety and electrical symbols may appear on the product or in this guide:

Symbol	Description
	Earth (ground) terminal
	Possibility of electric shock
	Caution
	Do not dispose of this product as unsorted municipal waste.

Terminal can be used to make a measurement ground connection. The terminal is NOT a Safety or protective Earth.

Appearance on the product indicates a need to read these safety and operation instructions.



### WARNING

To prevent injury or death only qualified personnel should use this product, only as instructed and with only accessories supplied or recommended. Protection provided by the product may be impaired if used in a manner not specified by the manufacturer.

## Maximum input voltage

The table and frequency derating plot below indicate the maximum input voltage for these probes. This is the maximum voltage that can be safely and accurately measured using the probes. The maximum input voltage depends on the signal frequency, the measurement category and also on the instrument with which the probe is used.



### WARNING

To prevent electric shock, do not attempt to connect voltages outside the probe's voltage rating, or above the oscilloscope's maximum input voltage multiplied by the attenuation ratio of the probe, whichever is lower. When using accessories with the probe, the lower rating / measurement category always applies to both probe and accessories connected to it. If an accessory is not marked with a voltage rating on either the connector, cable or body, or if a protective finger guard is removed, then do not exceed the EN61010 "hazardous live" limits overleaf.

Model	Instrument	Maximum input voltage
P2036 & P2056	In combination with PicoScope 6000E *	±200 V DC+AC peak (not in CAT II, III or IV)
	Maximum for probe with any instrument	300 V RMS (CAT II)
		400 V RMS (not in CAT II, III or IV)

\* When used with the PicoScope 6000E, maximum input voltage to the probe is limited to ten times the instrument's maximum measuring range of ±20 V.



**WARNING**

To avoid overloading the probe, note that its maximum input voltage rating decreases as the frequency of the applied signal increases.

Typical voltage derating P2036 & P2056  
No Measurement Category

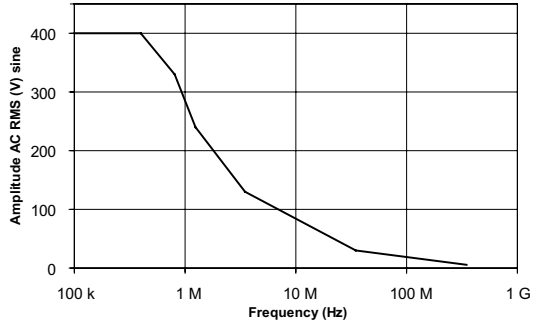

**WARNING**

Signals exceeding the voltage limits in the table below are defined as "hazardous live" by EN 61010.

Signal voltage limits of EN 61010-031:2015		
±60 V DC	30 V AC RMS	± 42.4 V pk max.

To prevent electric shock, take all necessary safety precautions when working on equipment where hazardous live voltages may be present.

**WARNING**

To prevent electric shock caused by accidental contact between a hazardous live voltage and the probe ground input, fit the insulating probe tip cap and do not use the probe tip ground spring or ground blade when working around hazardous live voltages. Where the risk of contact between a hazardous live voltage and the probe ground cannot be avoided, a differential isolating probe such as the TA041 listed on the Pico website must be used instead.

**WARNING**

To prevent injury or death, do not use this probe for measurements on mains installations in measurement categories III and IV.

**WARNING**

To prevent injury or death, do not use the product or an accessory if it appears to be damaged in any way, and stop use immediately if you are concerned by any abnormal operations.



**CAUTION**

Exceeding the voltage rating of any cable, connector or accessory can cause permanent damage to the oscilloscope and other connected equipment.

**Grounding**



**WARNING**

Never connect the ground input to, or allow it to touch, any electrical potential other than ground. To prevent personal injury or death, use a voltmeter to check that there is no significant AC or DC voltage between the probe ground and the point to which you intend to connect it.



**CAUTION**

Applying a voltage to the ground input is likely to cause permanent damage to the probe or other connected equipment.

It is good practice to connect the probe output to the measurement instrument and the ground lead to earth ground before connecting the probe to the circuit under test. Disconnect the probe input and the probe ground lead from the circuit under test before disconnecting the probe from the measurement instrument.

## External connections



### CAUTION

Take care to avoid mechanical stress or tight bend radii for all connected leads, including all coaxial leads and connectors. Mishandling will cause deformation and will degrade performance and measurement accuracy.

## Environment



### WARNING

To prevent injury or death, do not use in wet or damp conditions or near explosive gas or vapor.



### CAUTION

To prevent damage, always store your probe in appropriate environments.

	Storage	Operating
Temperature	-40 °C to +71 °C	0 °C to +50 °C
Max. humidity (non-condensing)	80 %	80 % to +31 °C, decreasing linearly to 40 % at +50 °C
Max. altitude	15 000 m	2 000 m
Pollution degree	2 As defined in IEC 61010-031. Only non-conductive pollution. Occasionally, however, a temporary conductivity caused by condensation must be accepted.	

## Care of the product

The probe contains no user-serviceable parts. Repair, servicing and calibration require specialized test equipment and must only be performed by Pico Technology or an approved service provider. There may be a charge for these services unless covered by the Pico two-year warranty.

Inspect the instrument and all probes, connectors, cables and accessories before use for signs of damage.



### WARNING

To prevent electric shock do not tamper with or disassemble the probe, case parts, connectors or accessories.



### CAUTION

When cleaning the product, use a soft cloth moistened, if necessary, with either distilled water or isopropyl alcohol. Before use allow the probe to dry completely. To prevent electric shock, do not allow liquids to enter the probe casing, as this will compromise the electronics or insulation inside.



### CAUTION

To avoid injury, handle with care especially when fitted with the extra thin and sharp spring contact tip.

## About the probe

The P2036 and P2056 from Pico Technology are state-of-the-art 10:1 miniature probes for oscilloscopes with up to 500 MHz bandwidth. The entire probe core is made of a high-quality CeramCore™ ceramic hybrid. Pure coaxial design and laser-trimmed resistors ensure highest signal fidelity along the signal path, offering high bandwidth and fast risetimes for accurate impulse measurements. With a maximum input voltage of 300 V CAT II, these probes are equally suitable in service and development environments. The read-out BNC connector is automatically recognized as a 10:1 attenuator by scopes such as the PicoScope 6000E Series that feature a sense ring.

The compact design with its 2.5 mm housing diameter at the tip provides better visibility on the DUT (device under test) in dense SMT circuits than conventional 5 mm housings.

The remarkably low input capacitance of only 9.5 pF applies a minimal load to the signal source, which is particularly important when measuring signals with fast risetimes. Only active or low-impedance probes can achieve lower loading than this.

The long ground leads found on most conventional probes bring additional inductance and resonances into the setup, which will result in false or inaccurate readings. The P2036 and P2056 are available with an IC contact system consisting of five different IC adaptors ranging from 1.27 to 0.5 mm pitch and a PCB adaptor kit, offering an ideal solution for short-circuit-proof, reproducible measurements. The probe is shipped with our signature spring-loaded tips. There are up to 16 different accessories included with the probe, offering adaptive solutions for almost every probing demand.

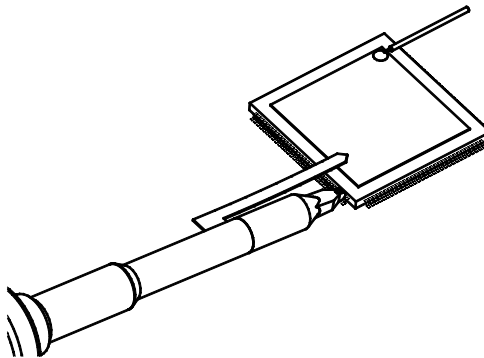

IC contact system with IC adaptor, ground blade and IC ground copper pad.

## Specifications

This User's Guide supersedes all previously published material. Specifications that are not marked as guaranteed are published as general information to the user. The instrument should have warmed up for at least 20 minutes and the environmental conditions must not exceed the specified limits of the probe. Note that specifications are subject to change without notice.

### Electrical specifications

	P2036	P2056	
Attenuation ratio*	10:1		(±2% at DC)
Voltage coefficient	0.00025 %/V		(at DC)
Probe bandwidth	300 MHz	500 MHz	(-3 dB)
Probe risetime	1 ns	700 ps	(10%–90%, typical)

\* Connected to oscilloscope with an input impedance of  $1\text{ M}\Omega \pm 1\%$ .

### Electrical characteristics

Input resistance (system)	10 M $\Omega$	± 1 %
Input capacitance (system)	9.5 pF	(typical)
Compensation range	10 pF to 25 pF	(typical)
Input coupling of the measuring instrument	1 M $\Omega$ AC / DC	

### Input impedance



#### CAUTION

To avoid overloading the circuit under test, note that the input impedance of the probe decreases as the frequency of the applied signal increases.

Typical input impedance P2036 & P2056

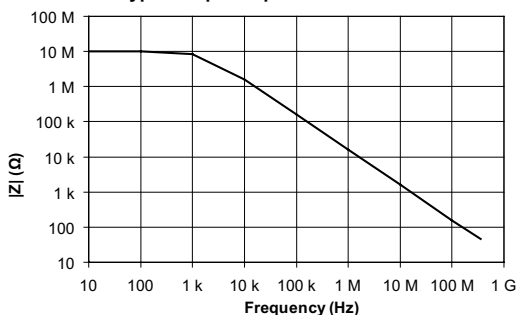

### Mechanical characteristics

Weight (probe only)	48 g
Cable length	1.3 m
Probe tip diameter	2.5 mm

## Adjustment procedure

The probe can be adjusted for low frequency (LF) compensation.

LF compensation is necessary whenever the probe is connected to a new oscilloscope input channel. LF compensation matches the probe's series capacitance to the oscilloscope's input capacitance. This matching assures good amplitude accuracy from DC to upper bandwidth limit frequencies. A poorly compensated probe influences the overall system performance (probe + scope) and introduces measurement errors resulting in inaccurate readings and distorted waveforms.

LF compensation is performed by connecting the probe to a suitable signal source such as:

- the CAL output on the oscilloscope front panel
- a good-quality 500 Hz square wave from the AWG output of a PicoScope
- a square wave output from an oscilloscope calibrator

and adjusting the LF compensation trimmer to obtain optimal square wave response. For examples see figures below.

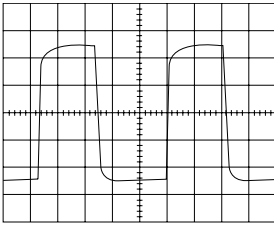

undercompensated

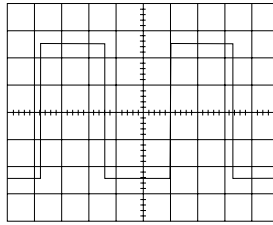

optimal

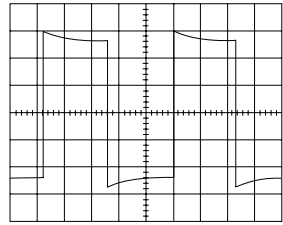

overcompensated

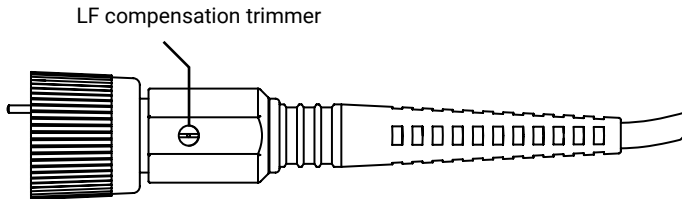



### Probe accessories

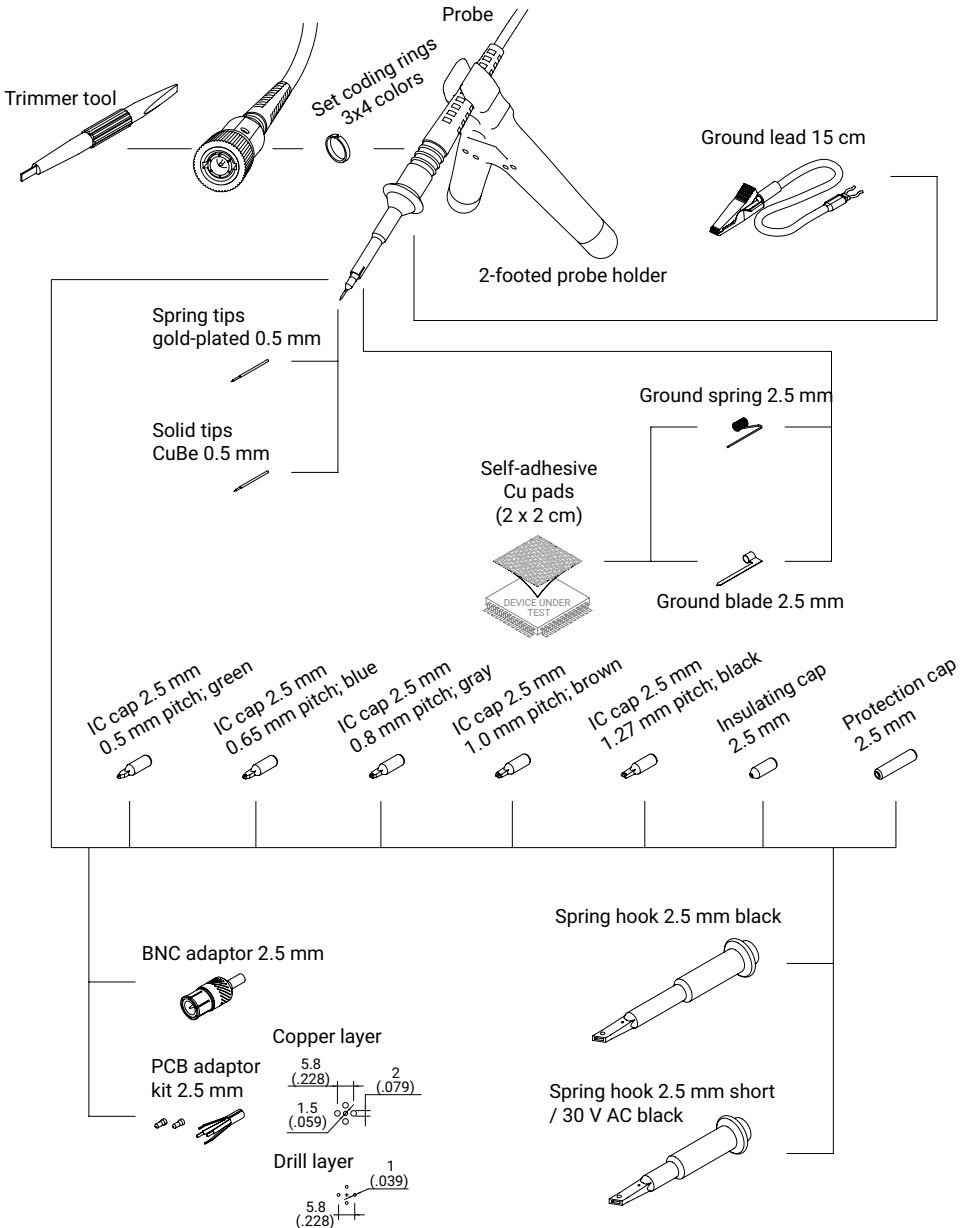

For further information on available accessories please refer to the accessory kits listed on page 10.

## Probe accessories

You can buy a range of kits containing accessories and spare parts for the P2036 and P2056 probes. Contents of the standard product packs and optional kits are listed below.

Item	TA479 P2036 300 MHz probe 2-pack	TA480 P2056 500 MHz probe 2-pack	TA066 basic accessory kit	TA067 standard accessory kit	TA065 advanced accessory kit	TA152 BNC adaptor kit	TA068 solid probe tips	TA064 spring contact tips	TA102 2-footed probe holder	TA436 P2036 300 MHz probe pack	TA437 P2056 500 MHz probe pack
Coding rings (set) 3 x 4 colors	1	1			1					1	1
Ground blade 2.5 mm					1					1	1
Ground lead 15 cm*	2	2	1	1	1					1	1
Ground spring 2.5 mm	2	2			1					1	1
IC cap 2.5 0.5 mm pitch, green					1					1	1
IC cap 2.5 0.65 mm pitch, blue					1					1	1
IC cap 2.5 0.8 mm pitch, grey					1					1	1
IC cap 2.5 1.0 mm pitch, brown					1					1	1
IC cap 2.5 1.27 mm pitch, black					1					1	1
Insulating cap 2.5 mm	2	2		1	1					1	1
PCB adaptor kit 2.5 mm					1					1	1
Self-adhesive Cu pad 2 x 2 cm					2					2	2
Solid tip, CuBe, 0.5 mm	2	2	1	1	1		5			1	1
Spring tip, gold-plated 0.5 mm	2	2	1	1	1			5		1	1
Spring hook, short, 2.5 mm / 30 V AC			1	1	1						
Spring hook 2.5 mm	2	2								1	1
Trimmer tool	1	1		1	1					1	1
BNC adaptor 2.5 mm <sup>†</sup>				1	1	1					
2-footed probe holder									1		



**\* WARNING**

To avoid injury and equipment damage, use for ground connections only.

**† WARNING**

To avoid exposure to dangerous voltages, do not use with signals above 42 V peak.

**WARNING**

All accessories are safety-tested. Replace only with Pico Technology accessories.

## Maintenance

### Changing the probe tip

To change the probe tip use pliers to grip and pull it carefully straight out of its contact socket, along the axis of the probe. Do not grip the white plastic insulator or the housing with pliers, because the tip could be squeezed and made impossible to remove and the probe could be damaged.

After the probe tip is removed, the new tip can be inserted with pliers into the contact socket along the axis of the probe. In order to insert the probe tip completely into the housing, press the probe tip carefully against a hard surface.

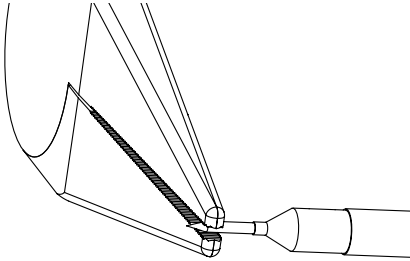

Use pliers to grip and pull the probe tip carefully out of its contact socket.

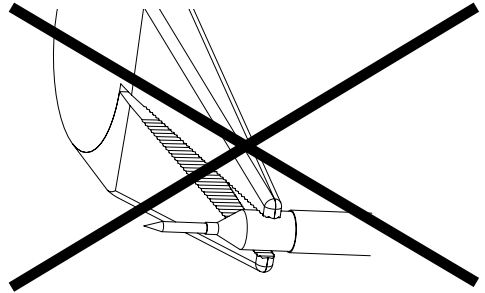

Do not grip the white plastic insulator or the probe housing with pliers.



**United Kingdom  
headquarters**

Pico Technology  
James House  
Marlborough Road  
Colmworth Business Park  
Eaton Socon  
St. Neots  
PE19 8YP  
United Kingdom

Tel: +44 (0)1480 396395

[sales@picotech.com](mailto:sales@picotech.com)  
[support@picotech.com](mailto:support@picotech.com)

[www.picotech.com](http://www.picotech.com)

**North America  
regional office**

Pico Technology North America, Inc.  
320 N Glenwood Blvd.  
Tyler  
TX 75702  
United States

Tel: +1 800 591 2796 (toll free)

**Asia-Pacific  
regional office**

Pico Technology  
Room 2252, 22/F, Centro  
568 Hengfeng Road  
Zhabei District  
Shanghai 200070  
PR China

Tel: +86 (0) 21 2226-5152

[pico.asia-pacific@picotech.com](mailto:pico.asia-pacific@picotech.com)